

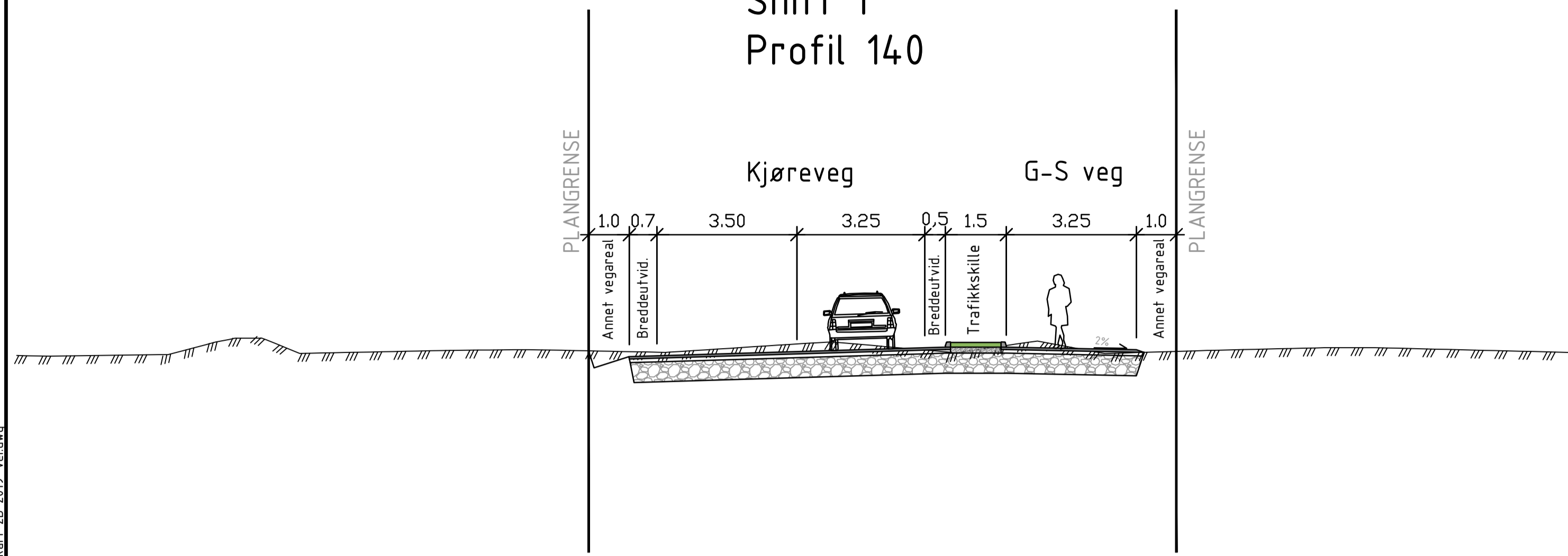

Filnavn: C:\Users\Katrine.Jensen\Bare & Leps&V\AS\100642 Espelhaugen - Plan - Dokumenter\09 Tegninger - DWG\04.0 3D modell\100642 Smalhusaugen\_C.dwg hatch.dwg Xref: xref:slendomsrensens.dwg 100642 Smalhusaugen - Basiskart 2D 2019 veidwg  
 Format: A1 Plott: katrine.jensen 06.05.2020 16:50

Snitt 1  
Profil 140



Snitt 4  
Profil 340

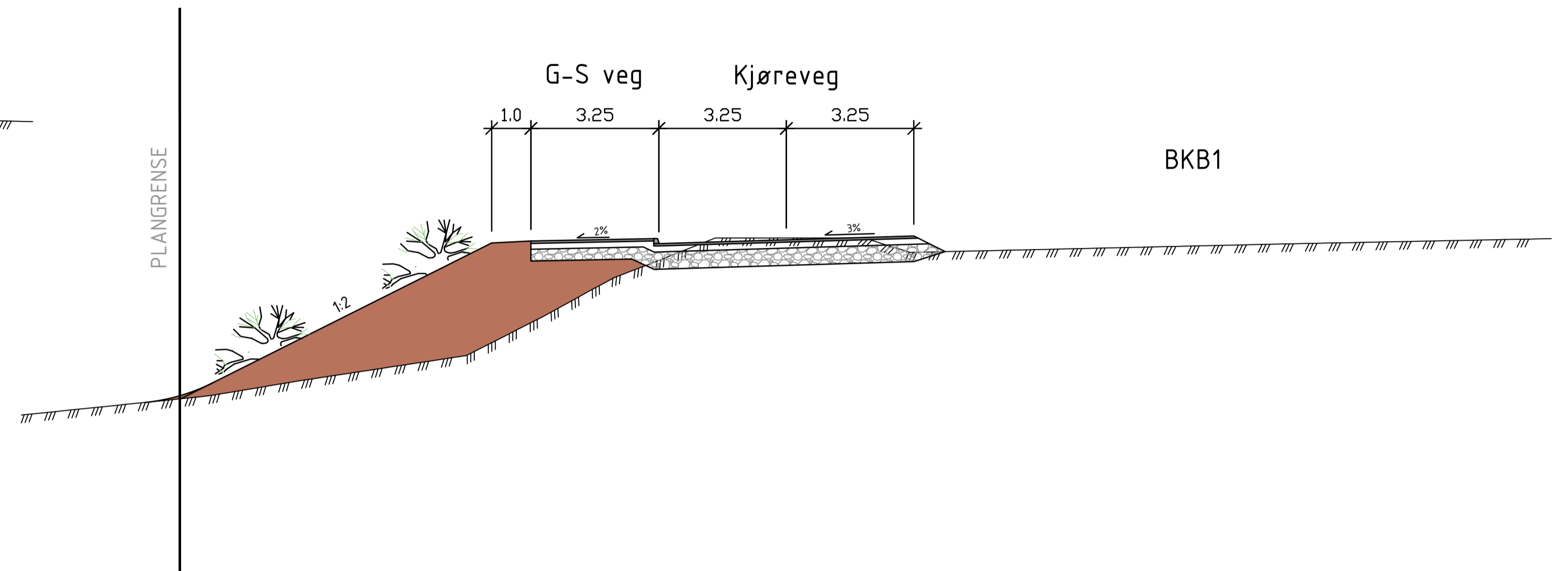

Snitt 2  
Profil 230

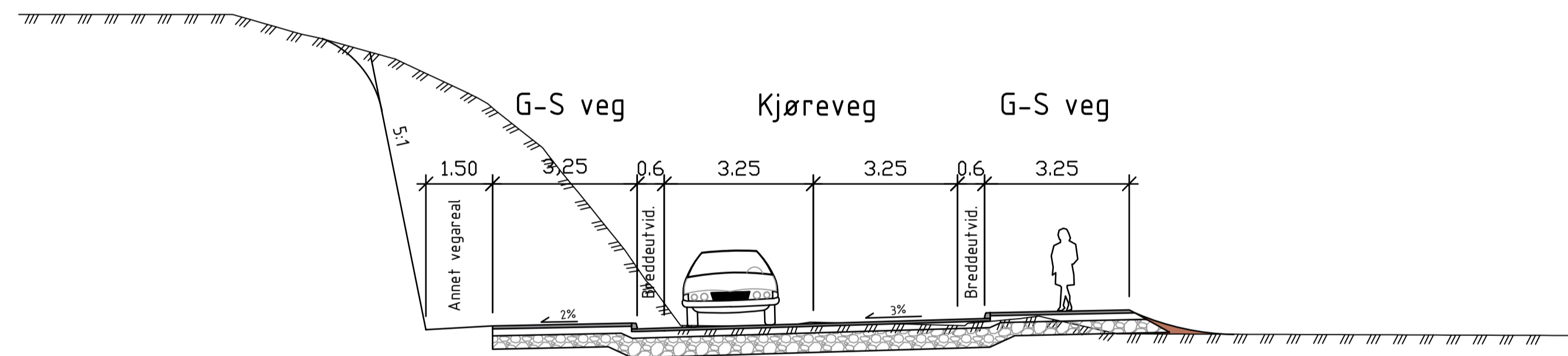

Snitt 5  
Profil 380

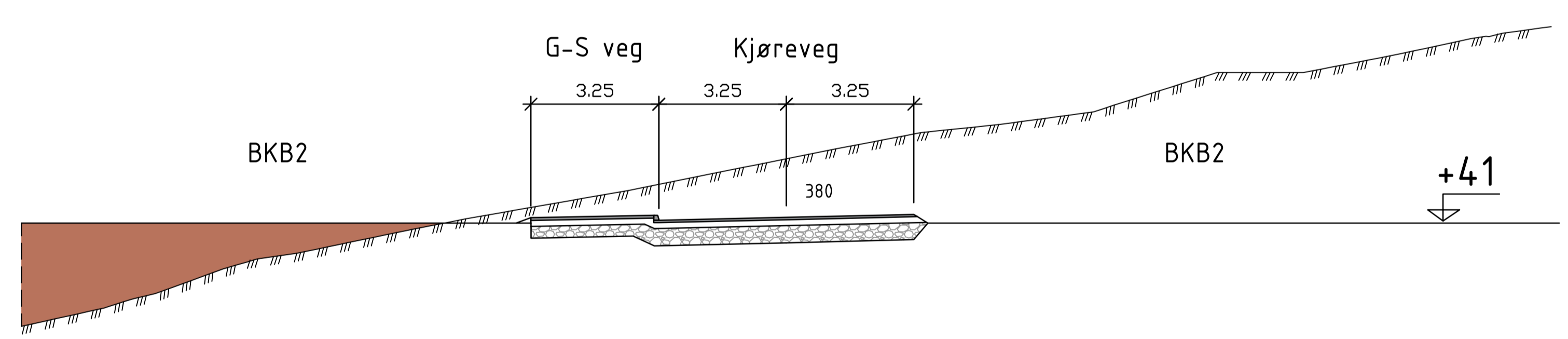

Snitt 3  
Profil 320

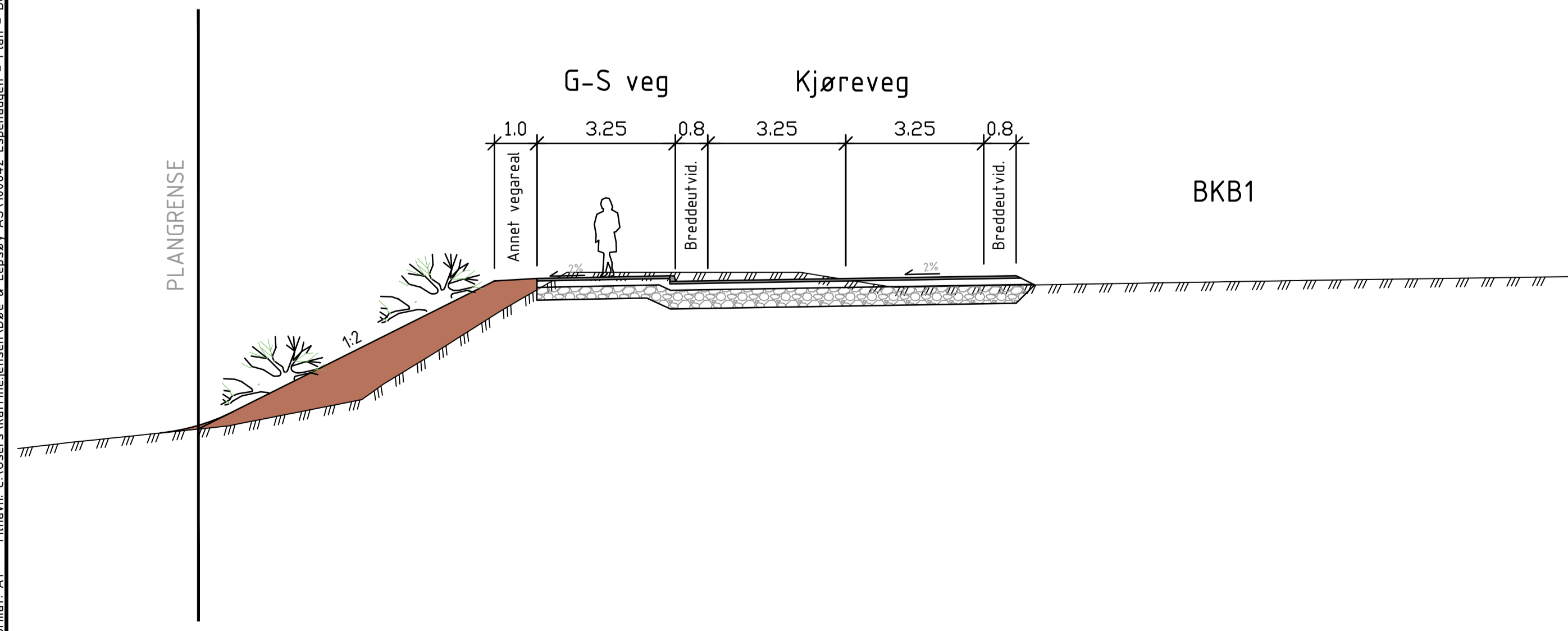

Pallas AS		Prosjektnr: 100642	
Ytrebygda, Gnr 107 bnr 26 mfl. Smalhusaugen		Dato: 06.05.2020	Tegnet: KJ
NORMALPROFILER UTVALGTE PROFILER		Målestokk: A1 1:100	Kontrollert: GBA
		A3 1:200	Godkjent: GBA
		Status: REGULERING	
A/STAB		Tegningsnr: U02	Rev:
Ulsmågevegen 7 5224 Nesttun		Tlf: 902 57 455	Epost: post@a-stab.no

Filnavn: C:\Users\katrine.jensen\Bare & Leps&V\AS\100642\Espeshaugen - Plan - Dokumenter\09\Tegninger - DWG\04.0 3D modell\100642 Smalhusaugen\_C.dwg hatch.dwg Xref: xref elementstrens.dwg 100642 Smalhusaugen - Basiskart 2D 2019 veidwg  
 Format: A1  
 Plott: katrine.jensen 06.05.2020 16:41

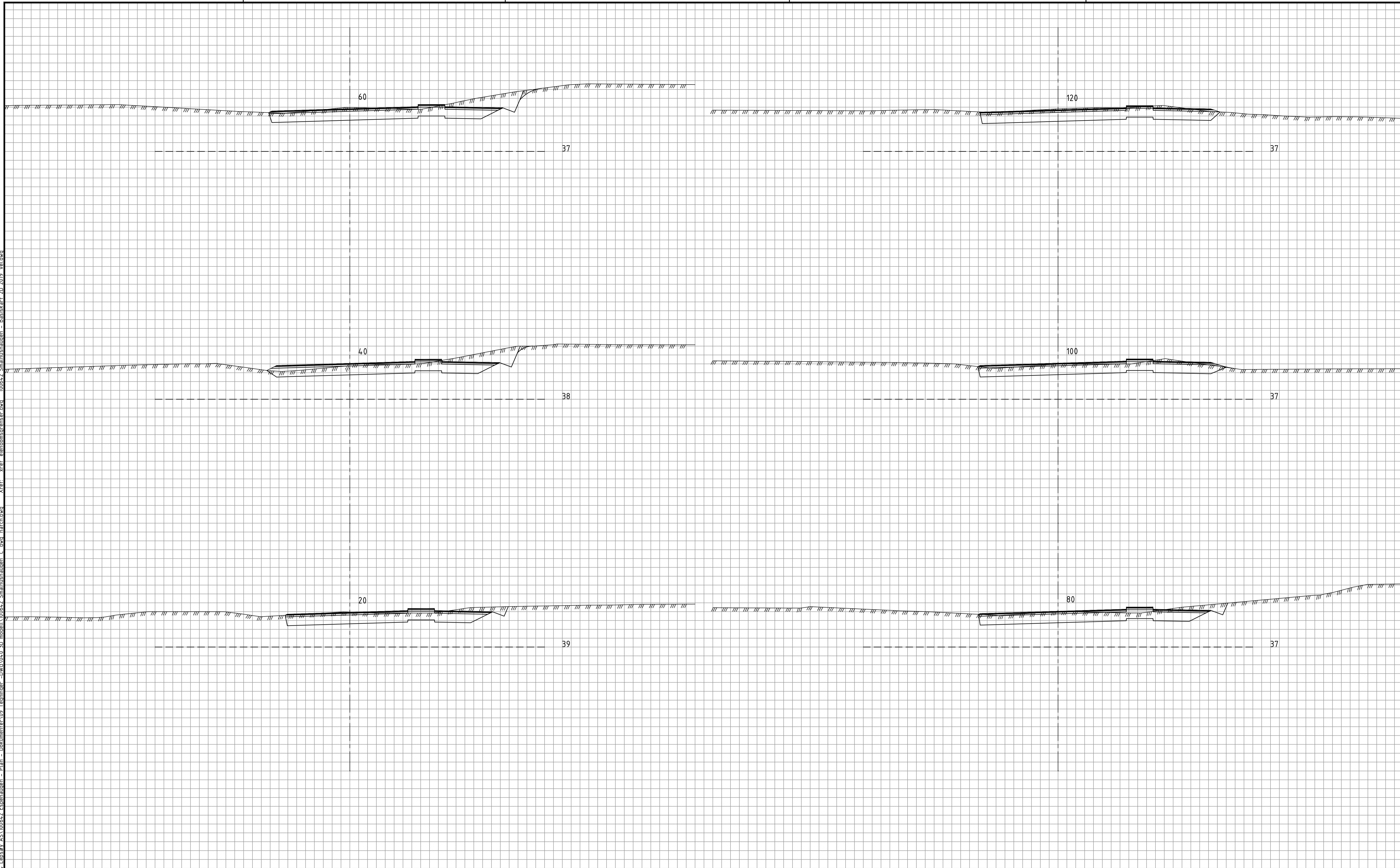

Rev.		Revideringen gjelder		Dato	Tegnet	Kontroll	Godkj
Pallas AS				Prosjektnr: 100642			
Ytrebygda, Gnr 107 bnr 26 mfl. Smalhusaugen				Dato	Tegnet		
				06.05.2020	KJ		
TVERRPROFILER				Målestokk	Kontrollert		
Pr. 20 - 120				A1 1:100	GBA		
				A3 1:200	Godkjent		
				GBA			
Status				REGULERING			
Tegnings nr				U01		Rev.	
<b>A/STAB</b>		Ulsmågvegen 7 5224 Nesttun		Tlf: 902 57 455 Epost: post@a-stab.no			

Filnavn: C:\Users\Katrine.jensen\Bare & Leps\A\AS\100642 Espelhaugen - Plan - Dokumenter\09 Tegninger - DWG\04.0 3D modell\100642 Småhushaugen\_C.dwg hatch.dwg Xref: xref: eiendomsrensning.dwg  
 100642 Småhushaugen - Basiskart 2D 2019 veidwg  
 Format: A1  
 Plott: katrine.jensen 06.05.2020 16:42

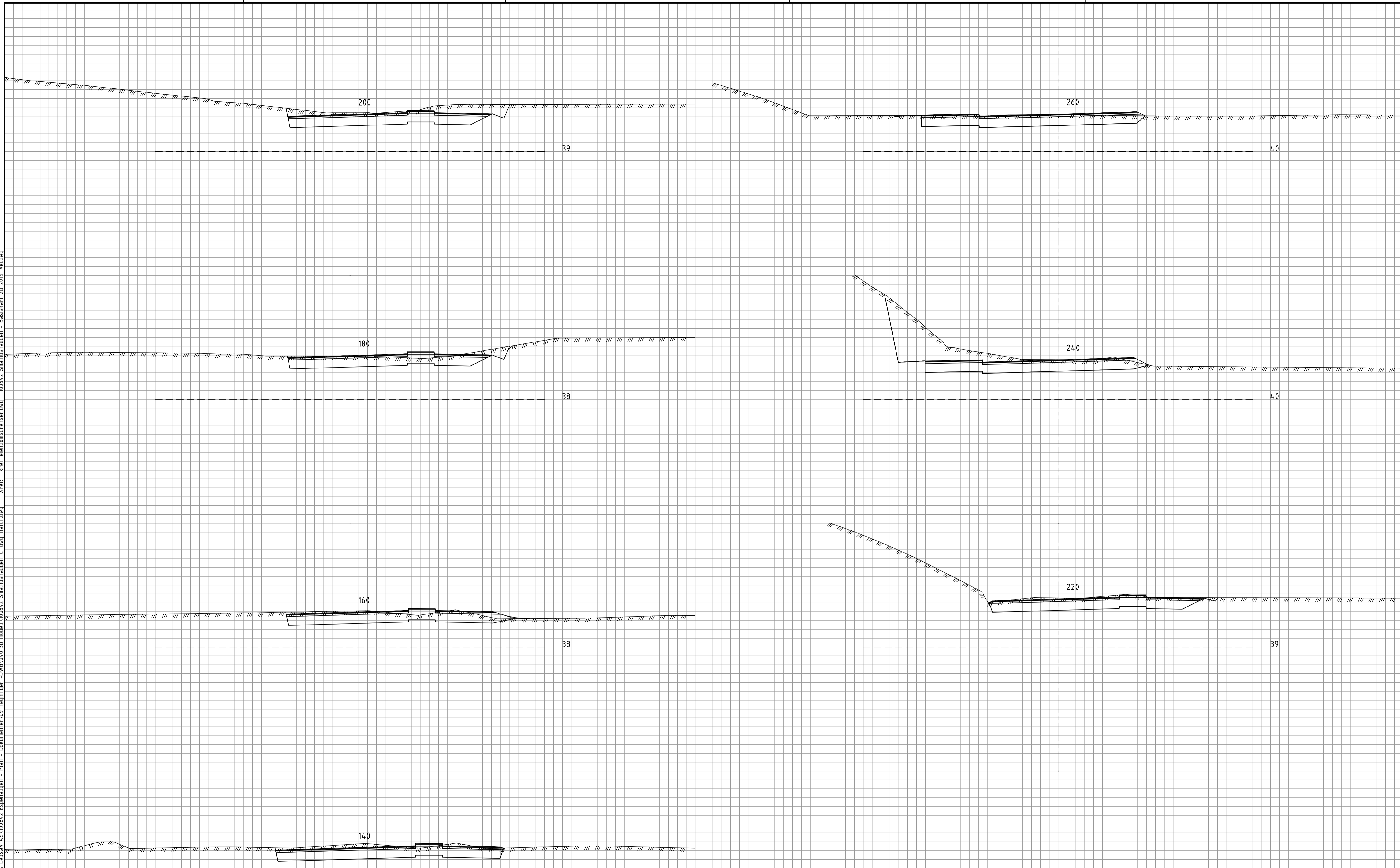

Rev.		Revideringen gjelder		Date	Tegnet	Kontroll	Godkj.
Pallas AS				Prosjektnr: 100642			
Ytrebygda, Gnr 107 bnr 26 mfl. Småhushaugen				Date	06.05.2020	Tegnet	KJ
TVERRPROFILER				Målestokk	A1 1:100	Kontrollert	GBA
Pr. 140 - 260				A3 1:200		Godkjent	GBA
Status				REGULERING			
Tegnings nr		U02		Rev			
<b>A/STAB</b>		Ulsmågevegen 7 5224 Nesttun		Tlf: 902 57 455 Epost: post@a-stab.no			

Filnavn: C:\Users\Katrine.jensen\Bare 8 - Leppsvik AS\100642 Espeshaugen - Plan - Dokumenter\09 Tegninger - DWG\04.0 3D modell\100642 Smalhushaugen\_C.dwg hatch.dwg Xref: xref elementstrensens.dwg 100642 Smalhushaugen - Basiskart 2D 2019 veidwg  
 Format: A1  
 Plott: katrine.jensen 06.05.2020 16:42

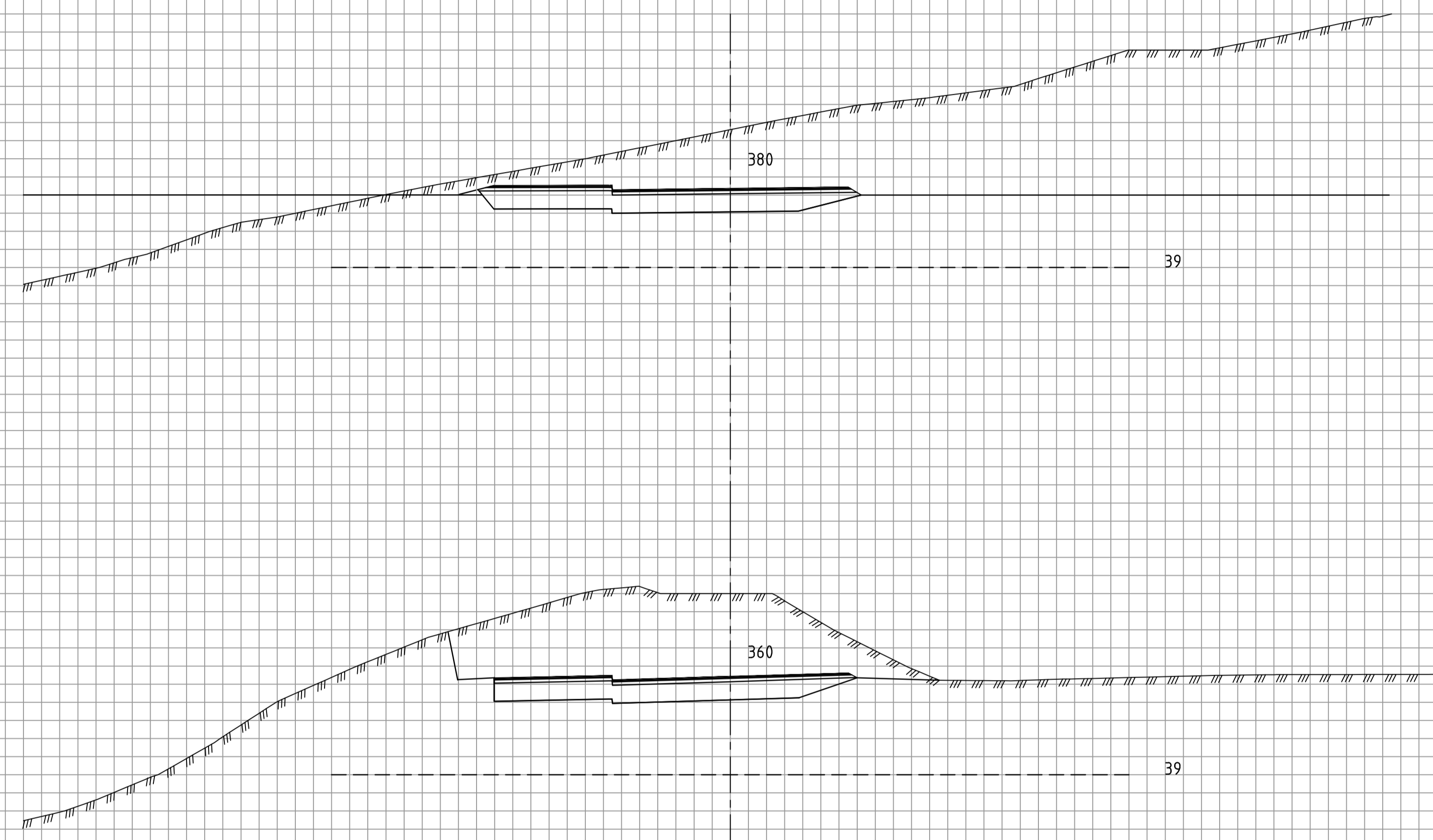
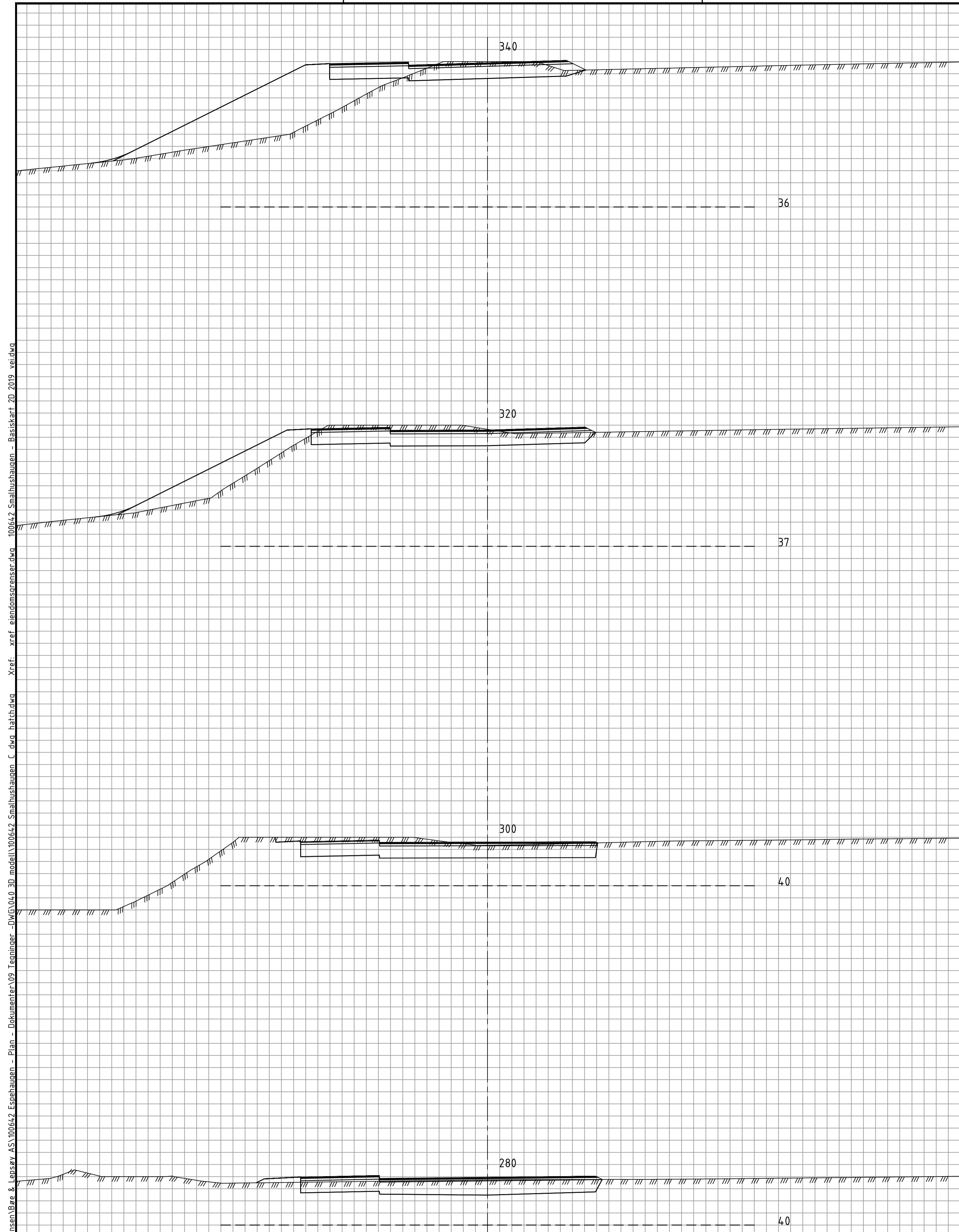

Rev.		Revideringen gjelder		Dato	Tegnet	Kontroll	Godkj
Pallas AS		Ytrebygda, Gnr 107 bnr 26 mfl. Smalhushaugen		Prosjektnr: 100642		Dato 06.05.2020	
TVERRPROFILER		Pr. 280 -380		Tegnet KJ		Kontrollert GBA	
				Godkjent GBA		Status REGULERING	
A/STAB		Ulsmågvegen 7 5224 Nesttun		Tlf: 902 57 455 Epost: post@a-stab.no		Tegnings nr U03	
						Rev.	